

MA 00045

2022-05-24 | 3

SAP: 6000010570



**Sortimo**<sup>®</sup>  
Intelligent Mobility

# Sortimo TopSystem

1000010554 | RET14-2P

Fiat Professional Talento 2016  
Opel Vivaro 2014  
Renault Trafic 2014  
Nissan NV300 2016  
Nissan Primastar 2021

**da-DK** **Vigtigt!** Læs og forstå den vedlagte sikkerhedsbrochure.

**de-DE** **Wichtig!** Lesen und verstehen Sie die beiliegende Sicherheitsbroschüre.

**en-EN** **Important!** Read and ensure that you have understood the enclosed safety brochure.

**es-ES** **¡Importante!** Asegúrese de leer y entender el folleto de seguridad adjunto.

**fr-FR** **Important !** Lisez attentivement la brochure de sécurité ci-jointe pour bien la comprendre.

**no-NO** **Viktig!** Les og forstå den vedlagte sikkerhetsbrosjyren.

**nl-NL** **Belangrijk:** Zorg ervoor dat u de bijgevoegde veiligheidsbrochure hebt gelezen en begrepen.

**sv-SE** **Viktigt!** Se till att läsa och förstå den bifogade säkerhetsbroschyren.

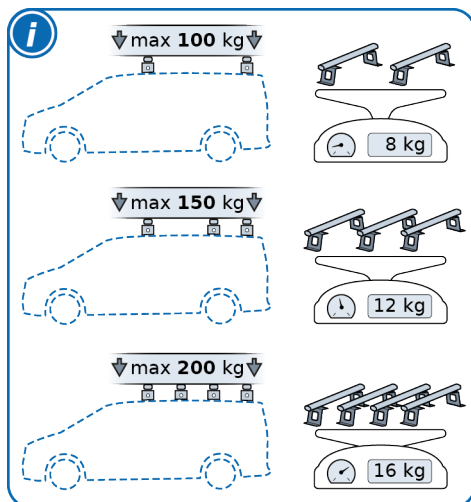

# 1

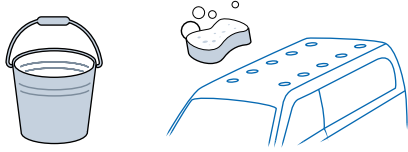

# 2

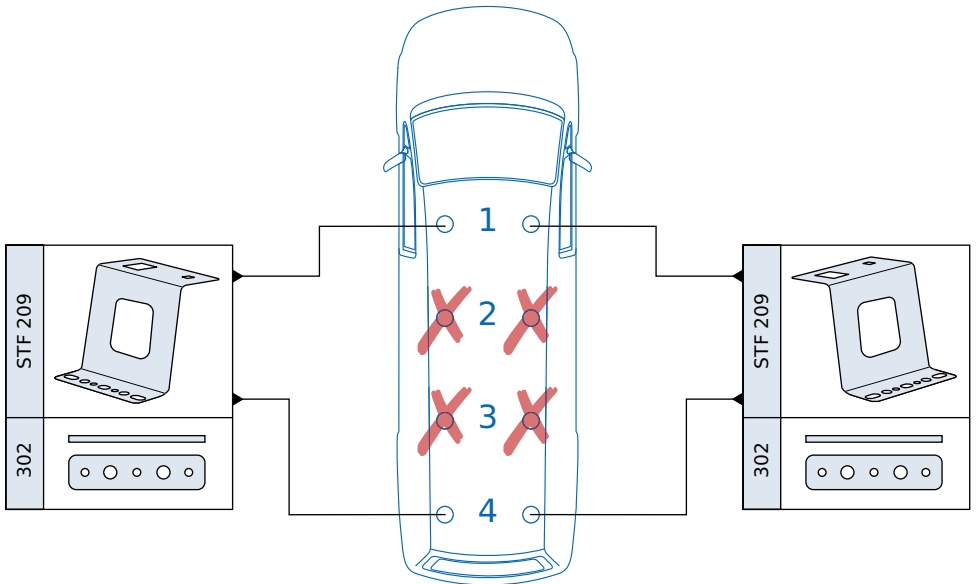
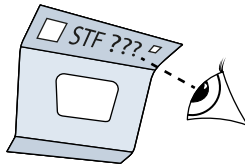

3

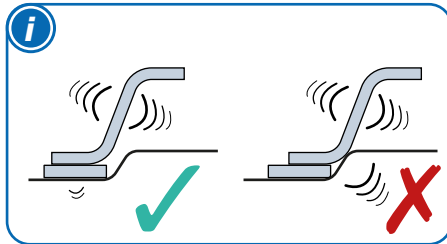
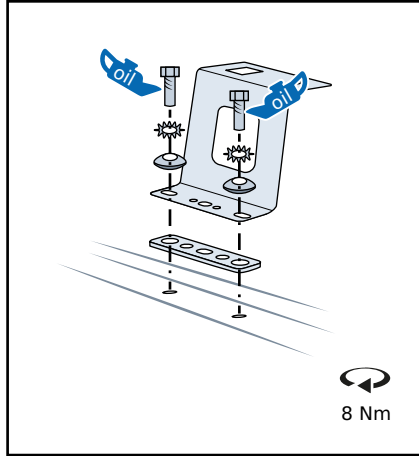
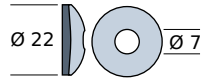
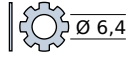
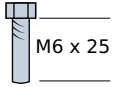

4

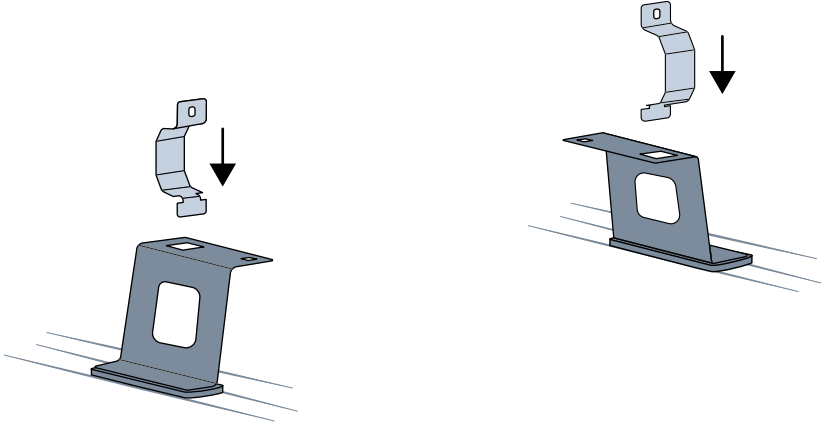

5

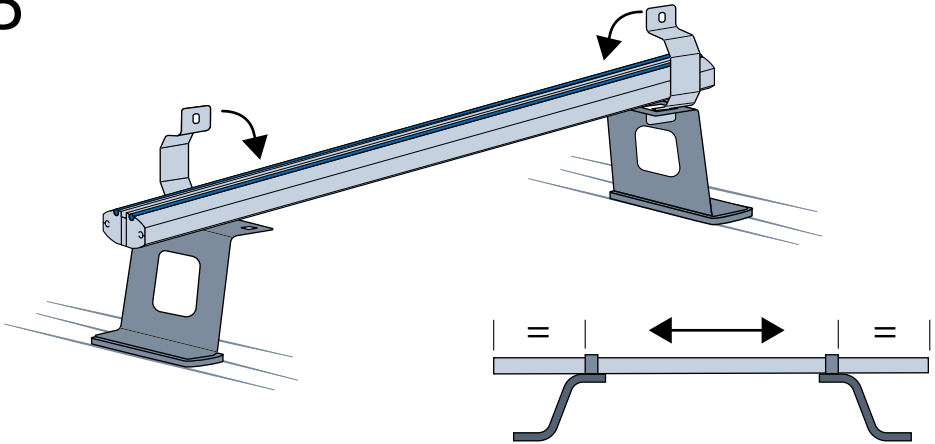

6

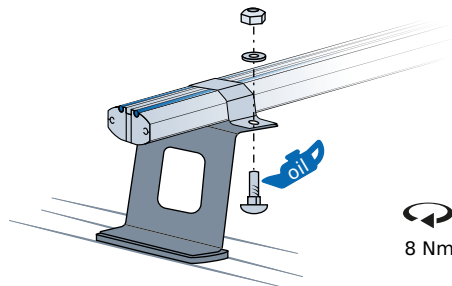
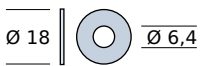
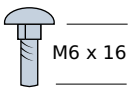

7

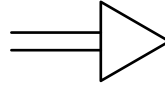

8

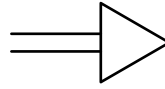
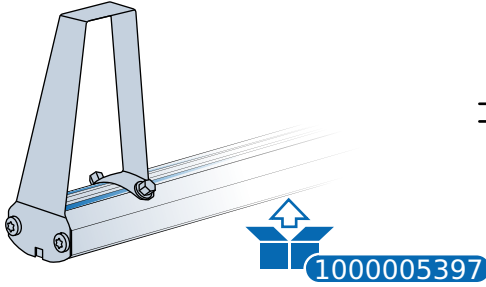

9-11

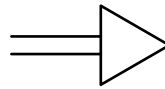
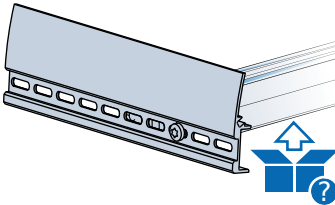

12-13

8

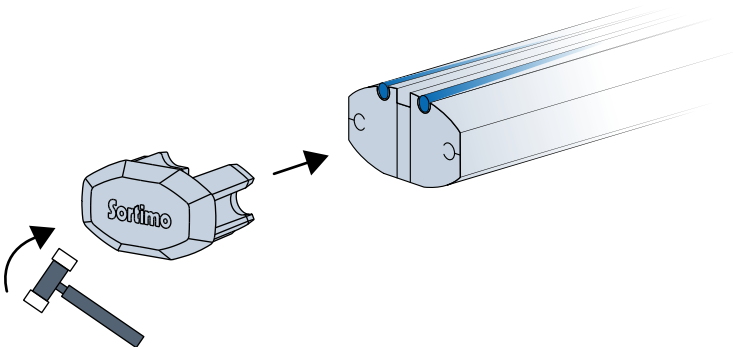

9

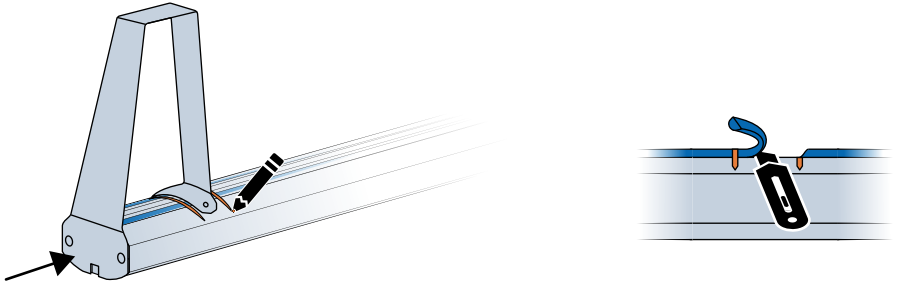

10

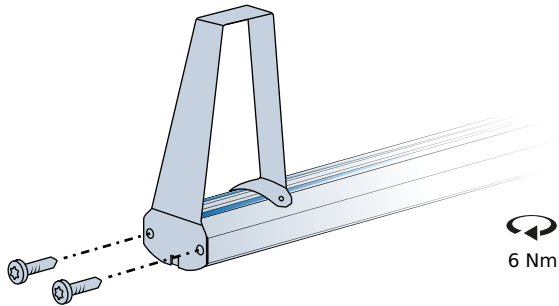

11

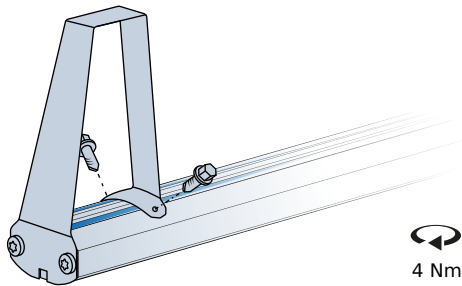
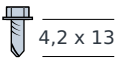

# 12

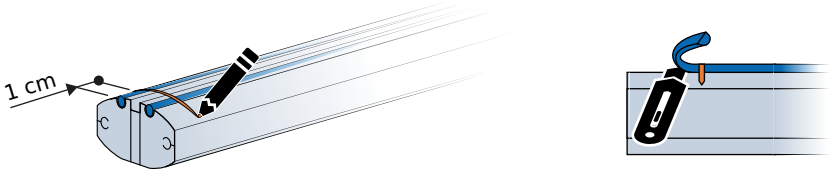

# 13

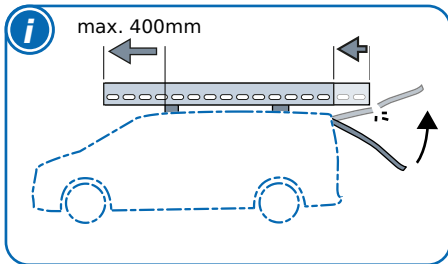
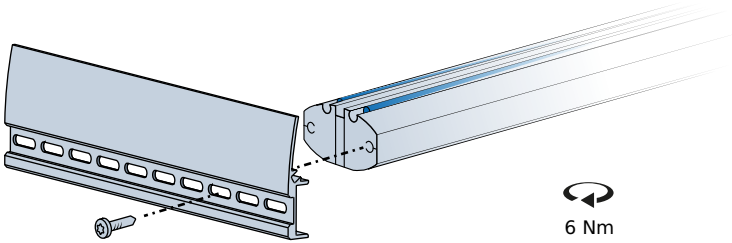

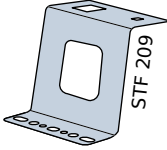

4X 6000003975

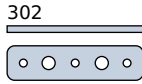

4X 6000004019

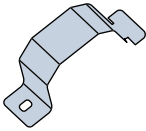

4X 1000005256

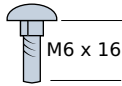

4X 6000003535



4X 6000003960



4X MT1016364

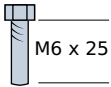

8X 6000003952



8X 6000003941



8X 6000011037



6000003819



6000011073

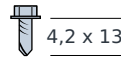

6000011074

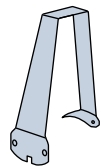

6000003849